

Słup prowadzący AKS01-24027035

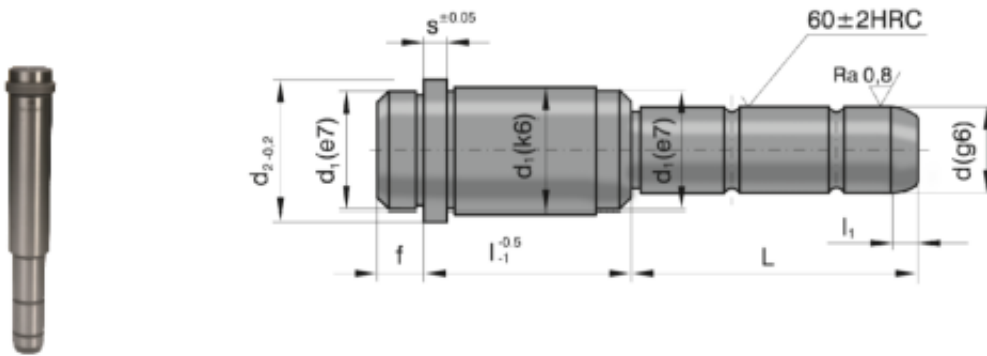

Opis produktu

Znormalizowane słupy prowadzące do form wtryskowych.



Dostępne rozmiary

model	D	d1	d2	s	f	l1	l	L		numer katalogowy	numer katalogowy
AKS01	18/20	26	31	6	9	7	22	35		AKS01-18022035	AKS01-20022035
							27	35		AKS01-18027035	AKS01-20027035
							46	65		AKS01-18046065	AKS01-20046065
							56	75		AKS01-18056075	AKS01-20056075
	22/24	30	35	6	9	7	22	35		AKS01-22022035	AKS01-24022035
							27	35		AKS01-22027035	AKS01-24027035
							36	55		AKS01-22036055	AKS01-24036055
							46	65		AKS01-22046065	AKS01-24046065
							56	75		AKS01-22056075	AKS01-24056075
							96	125		AKS01-22096125	AKS01-24096125
	30/32	42	47	6	9	7	27	45		AKS01-30027045	AKS01-32027045
							36	55		AKS01-30036055	AKS01-32036055
							46	65		AKS01-30046065	AKS01-32046065
							56	75		AKS01-30056075	AKS01-32056075
							66	75		AKS01-30066075	AKS01-32066075
							76	95		AKS01-30076095	AKS01-32076095
							86	95		AKS01-30086095	AKS01-32086095
							96	115		AKS01-30096115	AKS01-32096115
						116	155		AKS01-30116155	AKS01-32116155	