

Tuleja prowadząca AKS02-22027



Akrostal

Opis produktu

Znormalizowane tuleje prowadzące

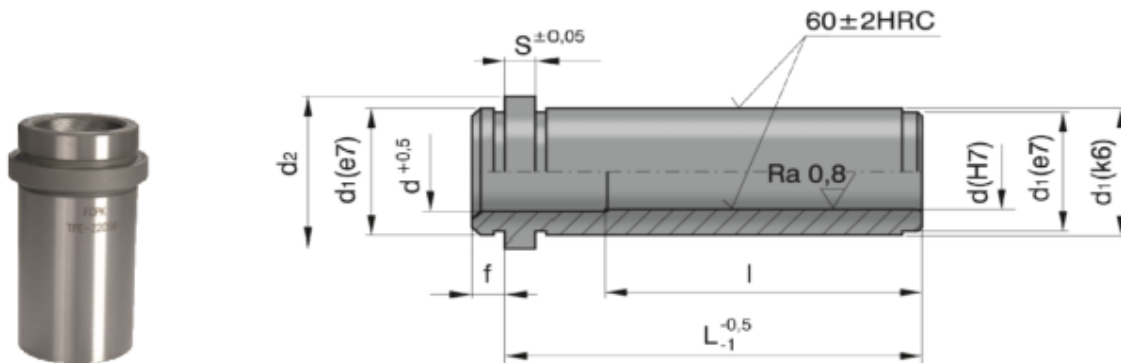

model	D	d1	d2	s	f	l	L	numer katalogowy	numer katalogowy
AKS02	18/20	26	31	6	9	31	22	AKS02-18022	AKS02-20022
						36	27	AKS02-18027	AKS02-20027
						55	46	AKS02-18046	AKS02-20046
						65	56	AKS02-18056	AKS02-20056
	22/24	30	35	6	9	31	22	AKS02-22022	AKS02-24022
						36	27	AKS02-22027	AKS02-24027
						45	36	AKS02-22036	AKS02-24036
						55	46	AKS02-22046	AKS02-24046
						65	56	AKS02-22056	AKS02-24056
						96	96	AKS02-22096	AKS02-24096
	30/32	42	47	6	9	36	27	AKS02-30027	AKS02-32027
						45	36	AKS02-30036	AKS02-32036
						55	46	AKS02-30046	AKS02-32046
						65	56	AKS02-30056	AKS02-32056
						75	66	AKS02-30066	AKS02-32066
						85	76	AKS02-30076	AKS02-32076
95						86	AKS02-30086	AKS02-32086	
105						96	AKS02-30096	AKS02-32096	
116	116	AKS02-30116	AKS02-32116						